

# Longday Bar Cart

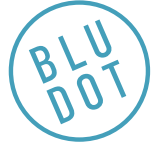

DESIGNED IN 2019

ASSEMBLY NOTES | REV 00

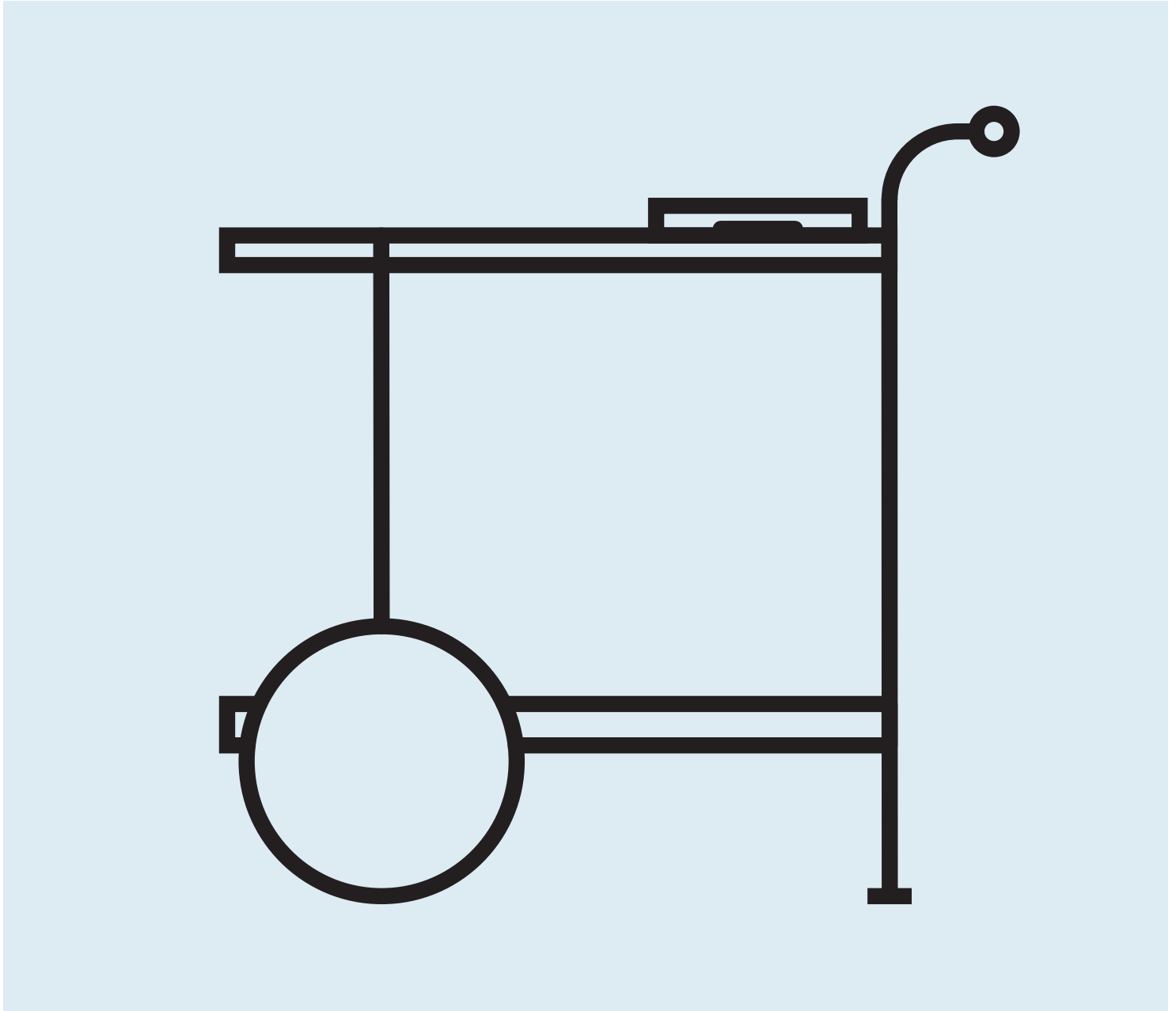

NEED A HAND?

Contact us at [service@bludot.com](mailto:service@bludot.com) or  
**844.425.8368** for assistance.

@BLUDOT

We design all our pieces in our Minneapolis studio. Follow  
along on Instagram for some sneak peeks into the process.

# Parts & Hardware

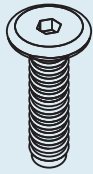

QTY \_\_\_\_\_ 6

PT. 1694

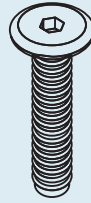

QTY \_\_\_\_\_ 2

PT. 1695

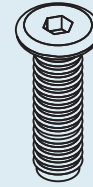

QTY \_\_\_\_\_ 2

PT. 1681

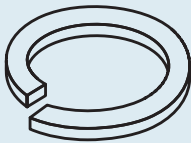

QTY \_\_\_\_\_ 8

PT. 3001

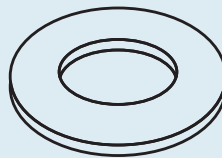

QTY \_\_\_\_\_ 8

PT. 3002

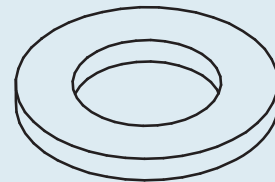

QTY \_\_\_\_\_ 2

Wheel Washer

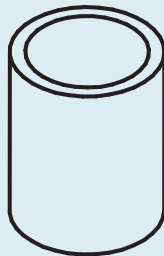

QTY \_\_\_\_\_ 4

Wheel Bushing

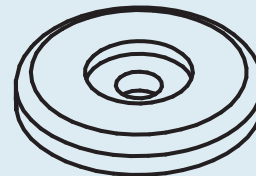

QTY \_\_\_\_\_ 2

Wheel End Cap

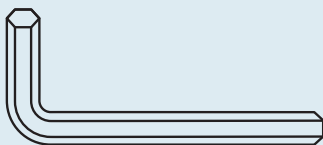

QTY \_\_\_\_\_ 1

PT. 9004

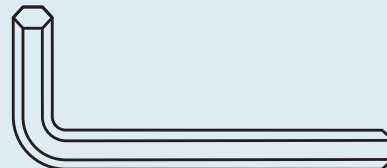

QTY \_\_\_\_\_ 1

PT. 9001

# Parts & Hardware



QTY 1

Handle A

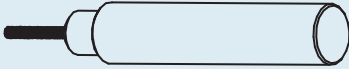

QTY 1

Handle B

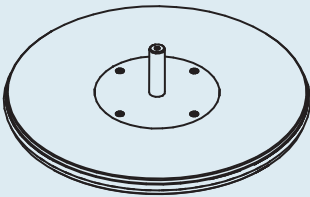

QTY 2

Wheel

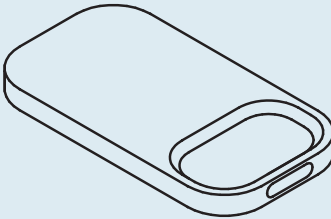

QTY 1

Tray

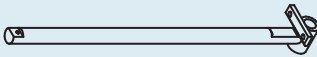

QTY 2

Short Upright



QTY 1

Tall Upright

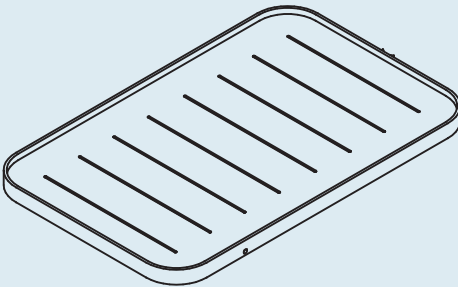

QTY 1

Upper Shelf

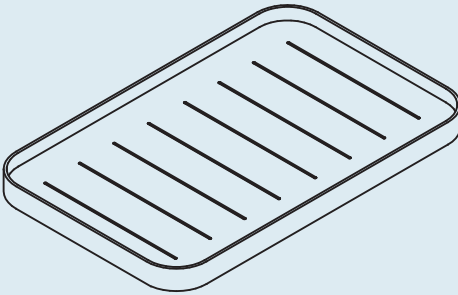

QTY 1

Lower Shelf

# Step 01

## ATTACH SHORT UPRIGHTS.

Assemble the bar cart on a soft surface to prevent damage during assembly. Attach the short uprights to the lower shelf as shown with the hardware provided.

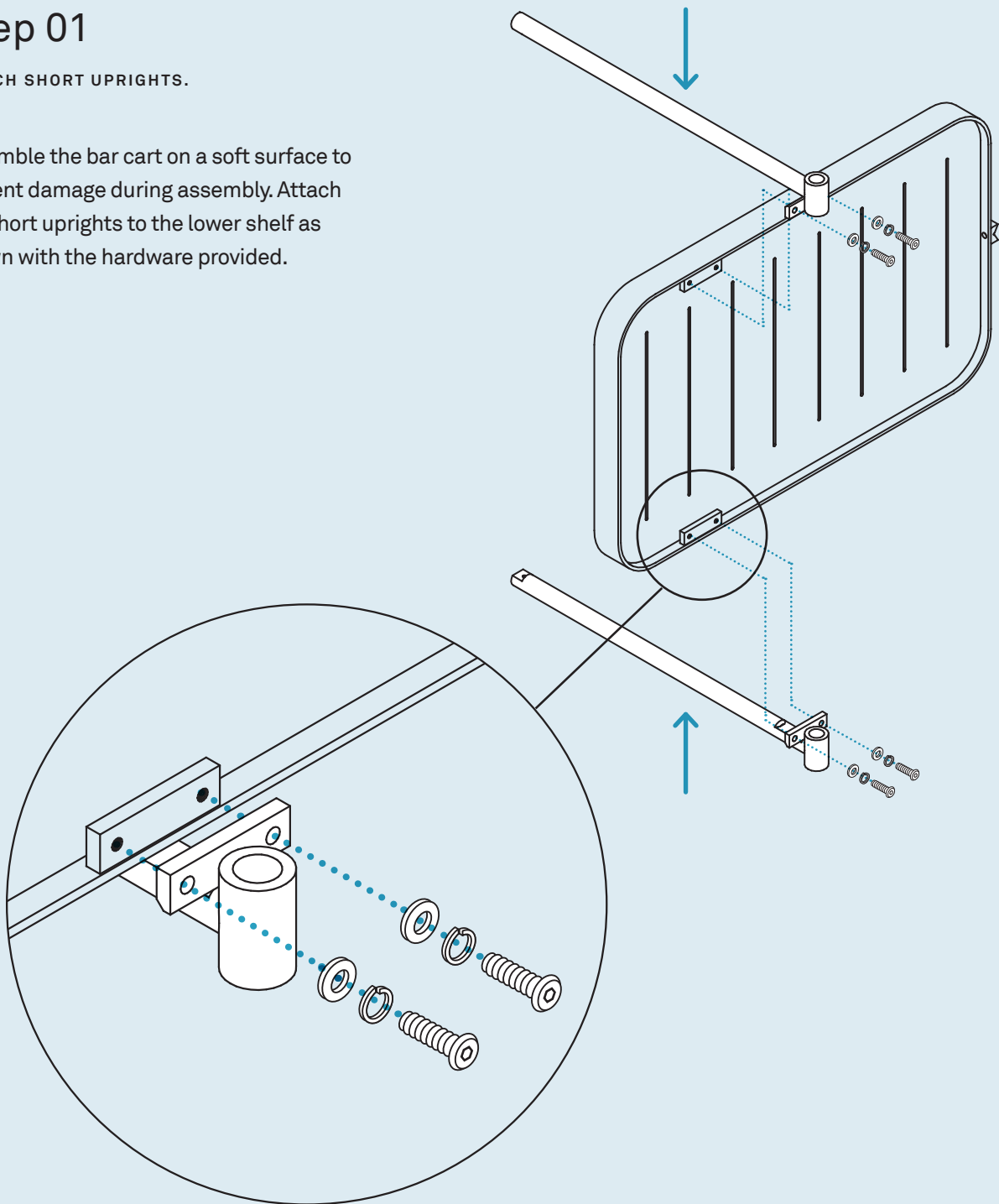

PT. 1694 x 4

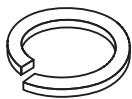

PT. 3001 x 4

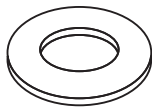

PT. 3002 x 4

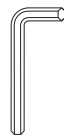





PT. 9004 x 1

# Step 02

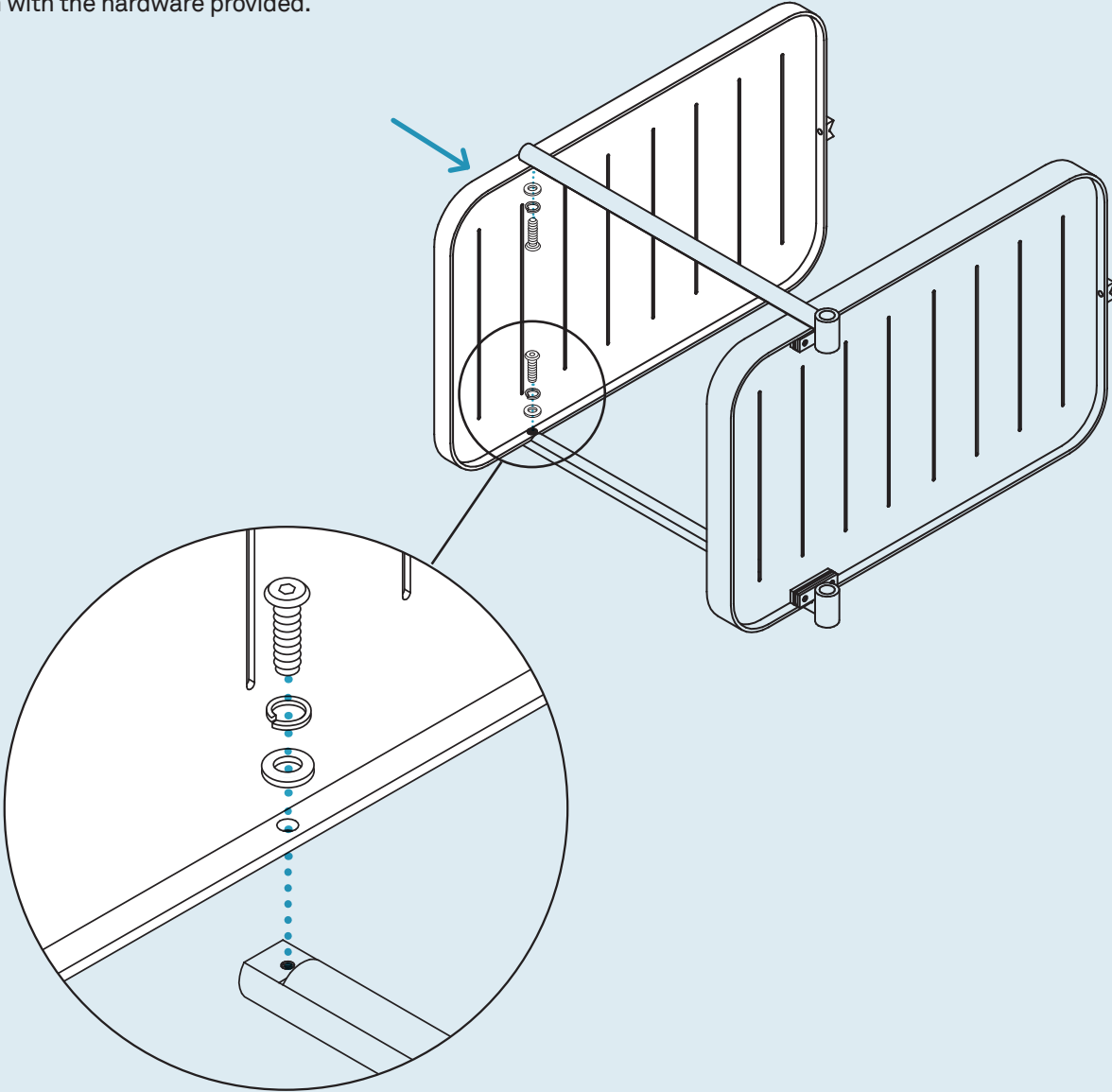
## ATTACH UPPER SHELF.

Attach the upper shelf to the short uprights as shown with the hardware provided.

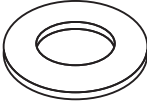

			
PT. 1694 x 2	PT. 3001 x 2	PT. 3002 x 2	PT. 9004 x 1

## Step 03

ATTACH TALL UPRIGHT.

Attach the tall upright to the shelves as shown with the hardware provided.

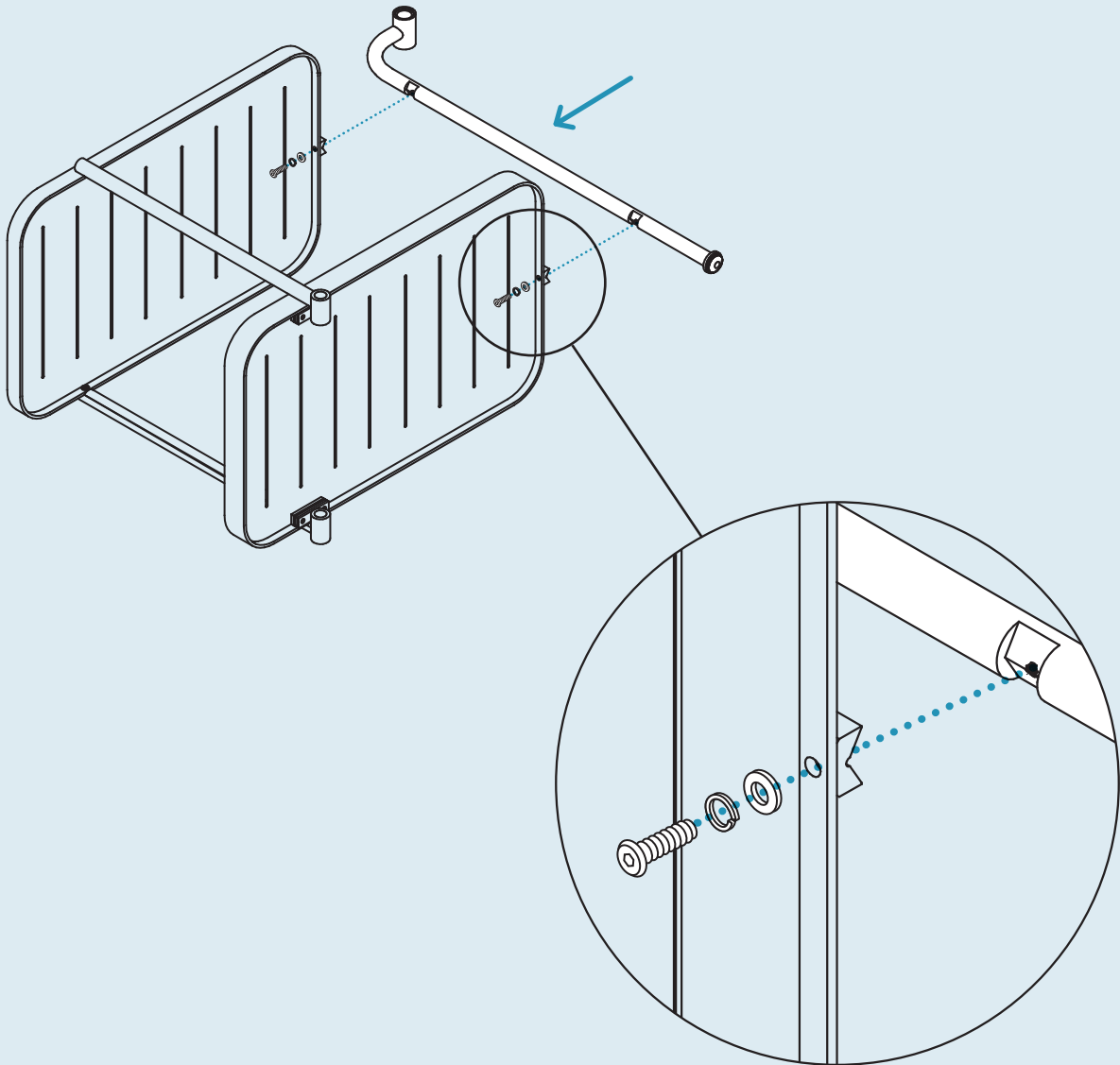

PT. 1695 x 2

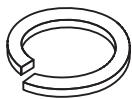

PT. 3001 x 2

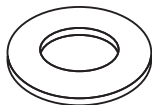

PT. 3002 x 2

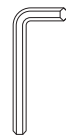

PT. 9004 x 1

# Step 04

## ATTACH WHEELS.

Attach the wheels to the short uprights as shown with the hardware provided.

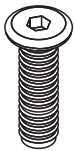
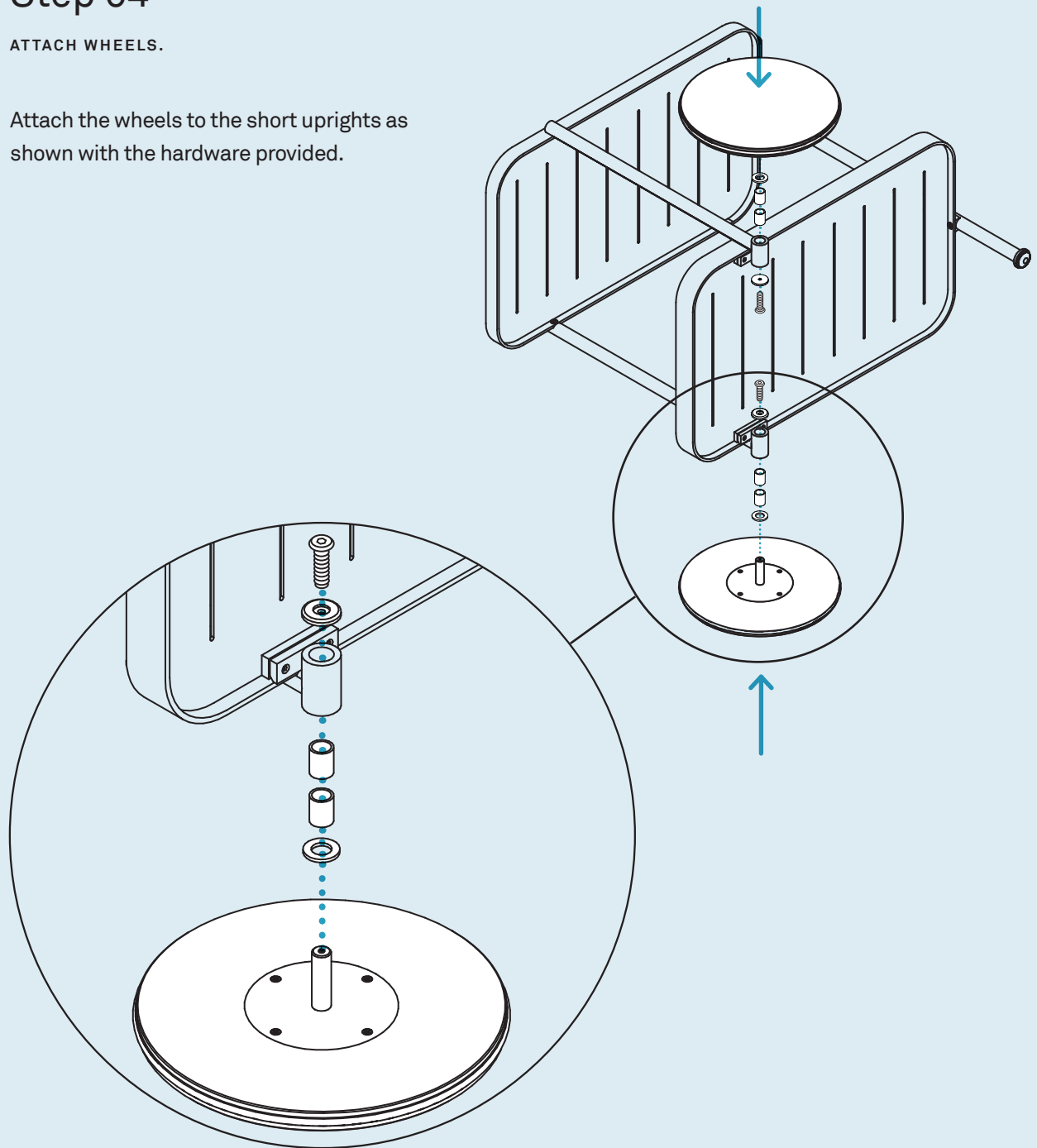

PT. 1681 x 2

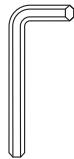

PT. 9001 x 1

## Step 05

### ATTACH HANDLES AND PLACE TRAY.

Attach handles by threading them together in the tube location as shown.

Place tray on shelf surface to complete assembly.

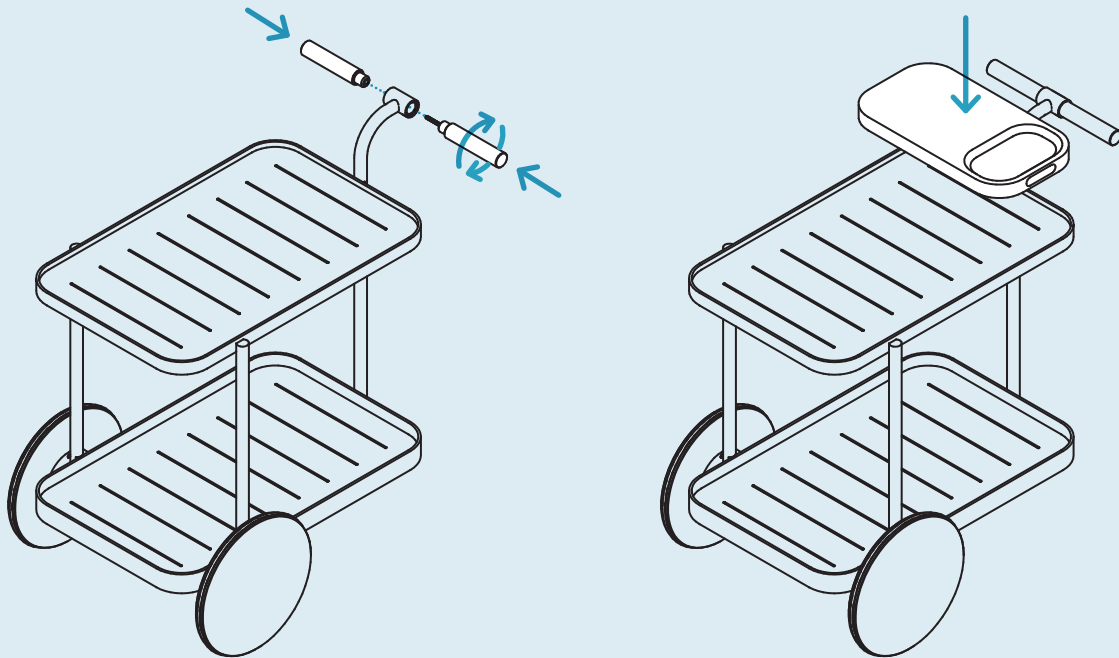

## Additional Information

### CLEAN

Clean metal surfaces with a slightly damp, soft cloth. To remove dirt and fingerprints, use a quality cleaner formulated for metal furniture. Wipe completely dry with a soft cloth.

### MAINTAIN

Weathering and color variation over time is natural for teak outdoor furniture. For best results, we recommend the following care: Wipe spills with a clean dry cloth, cover furniture in the off-season, and store indoors during winter months.

### PROTECT

To protect and revive weathered furniture, it is recommended to seal teak furniture. Water based sealants are most effective on bare wood, consult with your local hardware professional to select the sealant best suited for your outdoor furniture.